



INSTRUCTION MANUAL

VIBRATING WIRE FILL EXTENSOMETER

Model ERI

© Roctest Limited, 2009. All rights reserved.

This product should be installed and operated only by qualified personnel. Its misuse is potentially dangerous. The Company makes no warranty as to the information furnished in this manual and assumes no liability for damages resulting from the installation or use of this product. The information herein is subject to change without notification.

Tel.: 1.450.465.1113 • 1.877.ROCTEST (Canada, USA) • 33.1.64.06.40.80 (France) • 41.91.610.1800 (Switzerland)

www.roctest-group.com

E1117A-090626

TABLE OF CONTENTS

1	APPLICATIONS	1
2	PRODUCT	1
2.1	General description.....	1
2.2	Operation principle.....	2
2.3	Calibration.....	2
3	INSTALLATION PROCEDURE	3
3.1	Sensor assembly	3
3.2	Pre-installation acceptance reading.....	4
3.3	Sensor installation	5
3.4	In-line assembly installation.....	5
3.5	Cable installation	6
3.5.1	Cable identification	6
3.5.2	Cable routing	6
3.5.3	Horizontal cable runs.....	7
3.5.4	Vertical cable runs	7
3.6	Splices	8
3.7	Cable wiring.....	9
3.8	Lightning protection	9
3.9	Initial reading	9
4	READING PROCEDURE	10
4.1	Generalities.....	10
4.2	Taking measurements	10
4.3	Quick verification of measurements.....	11
5	CONVERSION OF READINGS	11
5.1	Displacement value	11
5.2	Temperature value.....	12
5.3	Temperature correction	12
6	TROUBLESHOOTING	13
6.1	Unstable reading.....	13
6.2	No reading	14
6.3	Temperature troubles	14
7	MISCELLANEOUS	15
7.1	Environmental factors	15
7.2	Conversion factors.....	15

1 APPLICATIONS

The ERI fill extensometer is designed for monitoring of displacements between two points inside any type of man-made fill. The base length (distance between the two end flanges) is variable and is generally from 2 to 30 meters.

The fill extensometer is normally installed horizontally in trenches. However, in some applications, it is installed vertically such as for measuring settlement at the point of contact with the foundation.

To monitor the lateral movement of embankment-dam cores or embankment spreading, several ERI are assembled together in series. The in-line assembly allows the deformation gradient to be measured over the whole length of the profile.

2 PRODUCT

2.1 GENERAL DESCRIPTION

The fill extensometer is comprised of the following:

- an outer protective telescopic PVC casing fitted with two end flanges.
- an inner stainless-steel rod. This rod is fixed at one extremity to an end flange and has a displacement sensor connected to its outer extremity. The displacement sensor consists of a vibrating wire transducer (Model JM).
- a four-conductor shielded cable linking the sensors to a junction or switching box or to a readout station.

The ERI comes with a standard 3 m base to which 1,2 or 3 m extension pieces can readily be added.

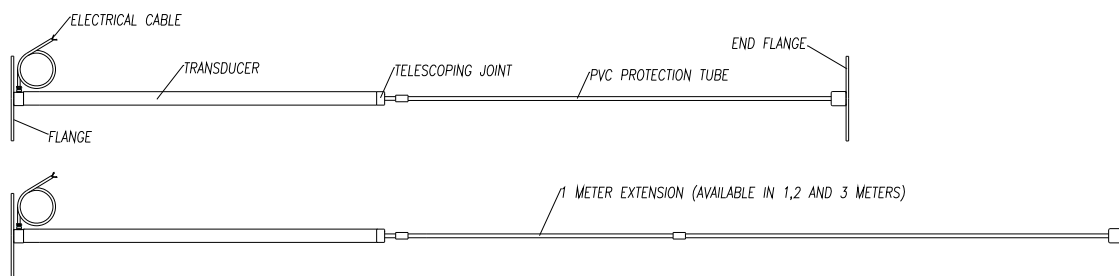

Figure 1: Model ERI fill extensometer

2.2 OPERATION PRINCIPLE

The sensing element is a piano wire attached to a spring mounted on a connecting rod. Movements of this rod in or out the gage body affect the tension of the wire through the spring. The tension is directly proportional to the square of the resonant or natural frequency of the wire.

In operation, plucking voltages are applied to a coil and a magnet located near the wire in a spectrum of frequencies, spanning the natural wire frequency, thus forcing the wire into vibration. The oscillation of the wire generates a voltage in the coil. This signal is amplified by the readout unit, which also discriminates against harmonic frequencies, to determine the resonant frequency of the wire.

The relationship between the period N and the strain ε in the vibrating wire is expressed by the following equation:

$$\varepsilon = K \cdot \frac{10^9}{N^2}$$

where ε = strain in micro-strain

N = vibration period in microseconds

K = gage constant, specific for each type of gage

The vibrating wire technology offers the unique advantage of a frequency output signal virtually unaffected by line impedance, or contact resistance.

Cable length of several kilometres can be used without signal deterioration.

Portable units as the MB-6T(L) are available to read the vibrating wire sensor (excitation, signal conditioning, display of different readings). Contact Roctest – Telemac for further information.

2.3 CALIBRATION

A calibration data sheet is supplied with each instrument. It enables conversion of gross readings into displacement values.

All the sensors are individually calibrated over their working range before shipment. The calibration factors are established by running the calibration data points through a polynomial regression formula.

Note: If a temperature correction has to be applied for specific applications, a special calibration will be done in factory for each sensor. Please refer to the temperature correction paragraph for more details.

3 INSTALLATION PROCEDURE

3.1 SENSOR ASSEMBLY

Generally, the ERI fill extensometer is shipped in several items. Hereby is presented a general procedure to assembly them. Always refer to the illustration assembly supplied with the instrument for exact identification of each component of your appropriate sensor.

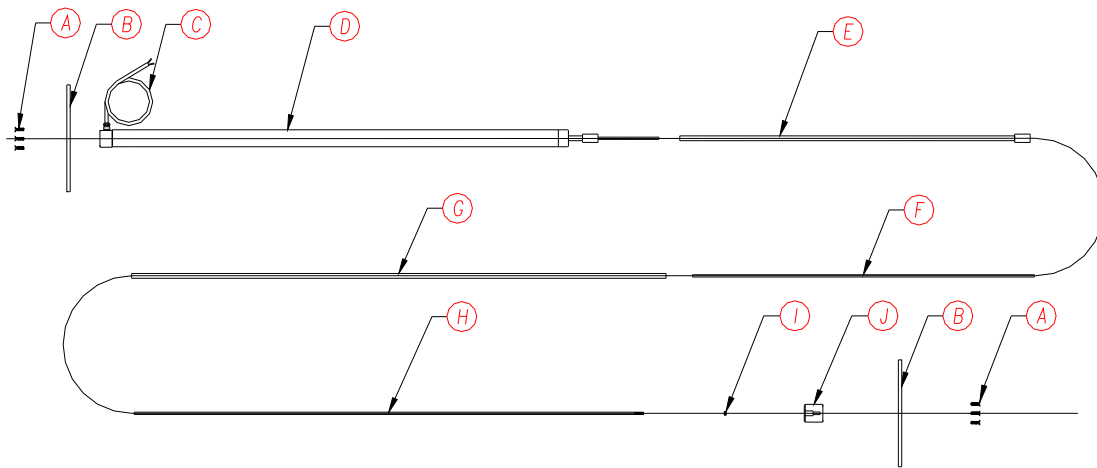
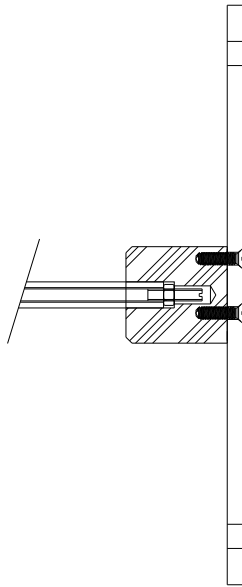

CHART			
ITEM	DESCRIPTION	DIMENSION	QTY
A	MACHINE SCREWS 1/4"-20 X 1"	---	6
B	FLANGE	300mm	2
C	ELECTRICAL CABLE	---	1
D	TRANSDUCER	1600mm	1
E	EXTENSION PROTECTION TUBING	3000mm	1
F	EXTENSION ROD	3000mm	1
G	END PROTECTION TUBING	1525mm	1
H	END ROD	1455mm	1
I	NUT	---	1
J	EXTREMITY ADAPTOR	---	1

Figure 2: Example of the different parts of an ERI

To assembly the instrument, screw the extension rod F on rod of part D. Use some glue (Loctite for example) on thread to make sure that the extension rod will not unscrew. Take care not to rotate the rod, because severe damage can occur to the sensor. Glue the tubing E to the tubing of part D with PVC cement. Screw the extremity rod (part H) to the extension rod (part F). Fix the end protection tubing (part G) over the end rod H and glue it on the tubing E. Install the nut I on the end rod until it sit on the end protection tubing G, and secure it with Loctite thread locker. Glue the extremity adaptor J on the end protection tubing with PVC cement. (See figure below) This will avoid the nut to move. Finally, install the flanges B using the 6 machine screws A.



Once the sensor assembled, take care not to rotate one flange relative to the other. Relative rotation of the end flanges could damage the spring and then the instrument.

3.2 PRE-INSTALLATION ACCEPTANCE READING

Gage readings should be taken as soon as the ERI fill extensometers are assembled to ensure they have not been damaged during shipment or handling on site.

As the ERI is generally used to measure differential displacements, it is not useful to check one absolute value. Therefore, a comparative reading is better. The following procedure can be used:

- Install a measuring tape along the ERI.
- Extend the sensor to first position (point A) and get the first reading. Note the value read on the tape.

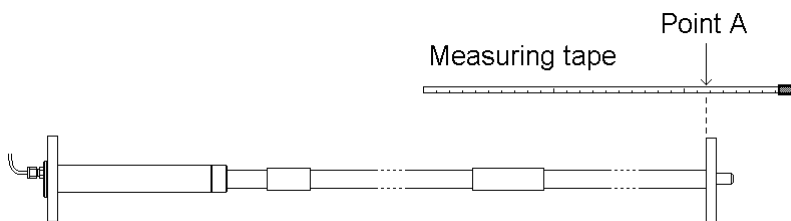

Figure 3a: First step to control the calibration

- Pull gently the rod to a second position (point B). Be sure to stay in the range of the instrument. Take a second reading and note the value read on the tape.

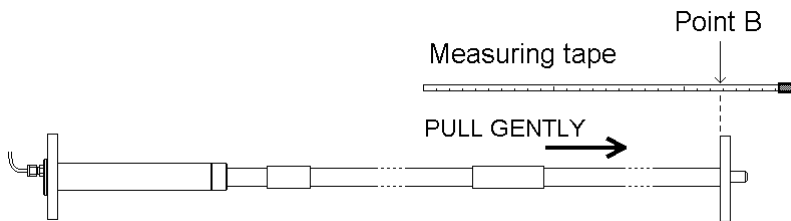

Figure 3b: Second step to control the calibration

- Compare the length between points A and B with both methods. It should be close.

For details about how to take readings, please refer to next chapter (Reading procedure).

3.3 SENSOR INSTALLATION

A trench of 0.5 m by 1 m wide is prepared. A 15 cm layer of sand is put in place and compacted. The fill extensometer is laid in the trench and the cable is run to the readout station.

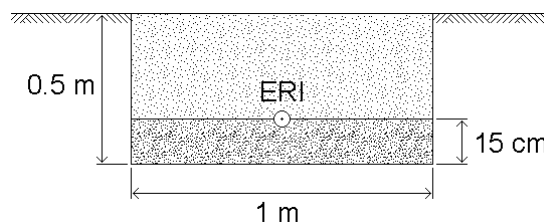

Figure 4: Draft of a trench

The extensometer is set by extending both tubes to the desired initial position. The initial distance between the end flanges is chosen according to the magnitude and direction of the expected movement. The range can be set for movements in compression, extension, or a combination of both.

3.4 IN-LINE ASSEMBLY INSTALLATION

In order to monitor deformations on huge distances, it is useful to use several ERI fill extensometers into one chain of instruments.

To be able to detect all deformations, especially those due to cracks, it is necessary to link rigidly the ERI sensors. If they are just laid one after the other, a movement can appear between two of them without any changes in measurements.

To build a chain, lay the first ERI in the trench, then a second one. Fix the adjacent flanges with bolts and nuts. Proceed the same way with the rest of the instruments constituting the chain.



Figure 5: Example of in-line assembly

3.5 CABLE INSTALLATION

3.5.1 CABLE IDENTIFICATION

The electrical signal coming from the sensor is transmitted through an electrical cable. This cable is generally supplied in rolls.

Cables are identified with the serial number that is labelled on the sensor housing. The serial number is stamped on a tag that is fastened to the readout end of the cable. In the case where the sensor cable has to be cut or if the cable end is inaccessible, make sure to be able to identify it (by marking its serial number for instance with an indelible marker or using a color code). It is very important to clearly identify the instrument for reading or wiring purposes.

3.5.2 CABLE ROUTING

Before backfilling, the cable must be laid with the utmost care. Loop the cable around the recess; make sure it is resting on a bed of hand placed and compacted screened soil.

Route the cable towards the junction or switching panel. Make sure that the cable is protected from cuts or abrasion, potential damage caused by angular material, compacting equipment or stretching due to subsequent deformations during construction or fill placement.

If necessary, run the cable through rigid or flexible conduit to the terminal location. To provide protection for cable running over concrete lifts, hand placed concrete is sometimes used, depending on site conditions.

Check that the cable does not cross over itself or other cables in the same area.

Surface installations require continuous surveillance and protection from the earth moving equipment circulating on the field.

During the cable routing, read the instruments at regular intervals to ensure continued proper functioning.

Record the cable routing with care and transfer this routing to the drawings.

3.5.3 HORIZONTAL CABLE RUNS

Some of the more important considerations that must be given to horizontal cable runs are:

- Avoid traversing transition zones where large differential settlements could create excessive strain in the cable.
- Avoid cable splices. If necessary, refer to the special paragraph below.
- Do not lay cables one on top of the other.
- Use horizontal snaking or vertical snaking of the cable within the trenches. For most materials, a pitch of 2 m with amplitude of 0.4 m is suitable. In very wet clays increase the pitch to 1 m. It enhances the elongation capability of the electrical cable.
- Use a combination of horizontal and vertical snaking at transition zones.

In rock fill dams with earth fill cores, it is frequently convenient to install cable in trenches in the core and fine filter zones, and in ramps in the coarse filter and compacted rock fill shell zones. Individual cables should be spaced not less than 2 cm apart, and no cable should be closer than 15 cm to the edge of the prepared layer. In instances in which cables must be placed in a given array, the cables should be separated from each other by a vertical interval of not less than 15 cm of selected fine embankment material.

During the backfill of trenches in earth dams, a plug, approximately 60 cm in width, made of a mixture of 5% bentonite (by volume) from an approved source and exhibiting a free swell factor of approximately 60%, and 95% embankment material, can be placed in the trenches at intervals of not greater than 7.5 m. The bentonite plugs reduce the possibility of water seepage through the embankment core along the backfilled trenches.

3.5.4 VERTICAL CABLE RUNS

The procedure shown below is an efficient and safe way to route cables from the sensor to the top of the embankment or of the dam.

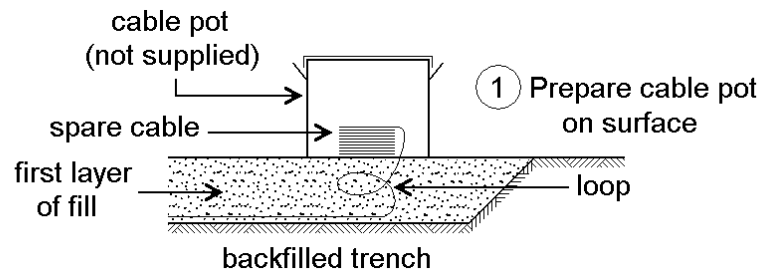

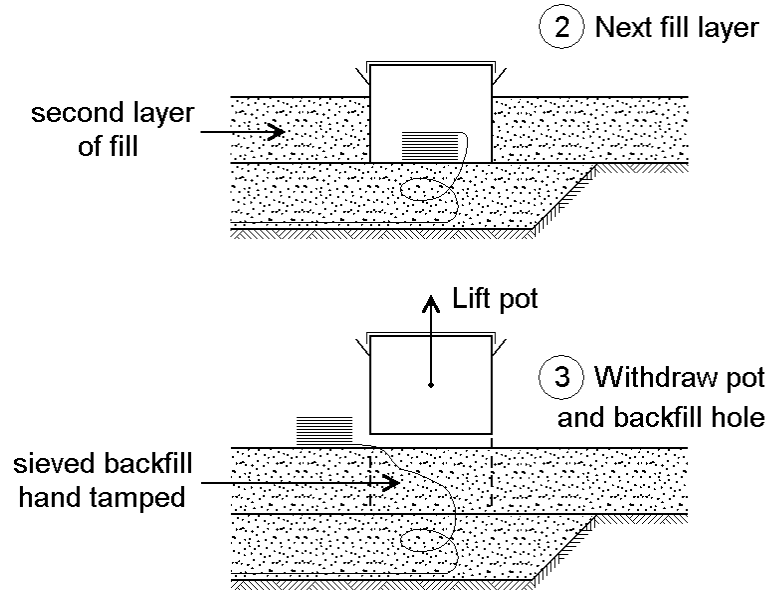

Figure 6: Procedure to route vertically cables (continued)

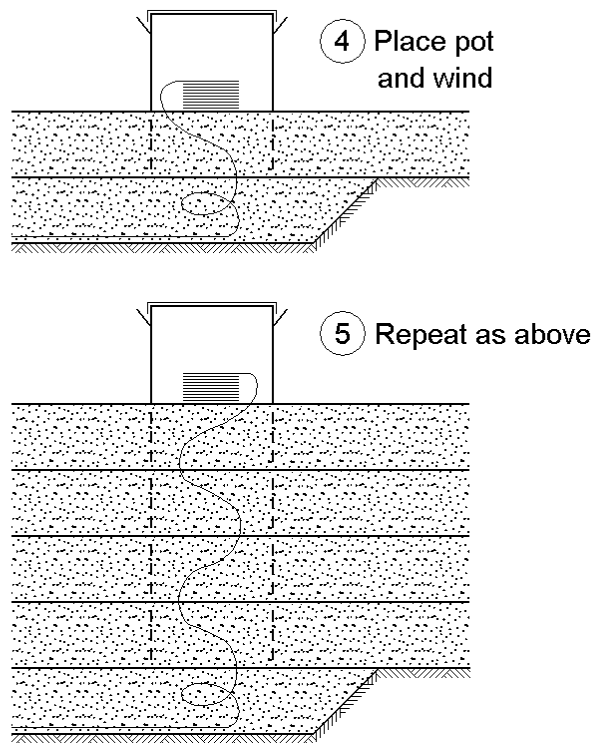

Figure 6: Procedure to route vertically cables

3.6 SPLICES

Generally, cable splices are to be avoided. If necessary, use only the manufacturer's approved standard or high-pressure splice kit. Splicing instructions are included with the

splice kit.

Should the cable be cut, we recommend the use of our high pressure cable splice kits, especially if the splice is located underwater.

Because of the vibrating wire technology the sensor uses, the output signal is a frequency, not affected by the impedance of the cable. Therefore, splices have no effect on the quality of the readings.

Furthermore, in special cases on site (large distance between sensors, chain of instruments, readout position for example), splices are useful to limit the number of cables to lay. Actually, individual sensor cables can be merged into a multi-conductor cable using a splice or a junction box.

Please contact Roctest – Telemac for additional information about junction boxes and splice kits.

3.7 CABLE WIRING

Before cutting a cable, make sure of its identification. If a cable has to be cut to be connected to a junction box for example, cut it in such way to have enough length to obtain a correct installation (functional and aesthetic).

Strip back the conductor insulation by about 1cm. If possible, tin the exposed conductors with a solder.

3.8 LIGHTNING PROTECTION

At all times during the installation, any cable that is exposed to potential damage by lightning must be protected.

A large grounded metal cage placed over the cable bundle, combined with direct grounding of all leads and shields is an effective way to prevent lightning damage to the instruments and cables during the installation process.

Please contact Roctest – Telemac for additional information on protecting instruments, junction boxes and data logging systems against power surges, transients and electromagnetic pulses.

All junction boxes and data logging systems furnished by Roctest – Telemac are available with lightning protection.

3.9 INITIAL READING

The reading taken after compaction is considered as the initial reading. Calculate it in millimetres. All subsequent readings are referenced to the initial reading. It applies also to the temperature reading.

For details about how to take readings, please refer to next chapter.

4 READING PROCEDURE

4.1 GENERALITIES

Readings can be taken manually with a portable readout unit model MB-6T(L) or automatically when connected to a SENSLOG data acquisition system.

Each vibrating wire ERI fill extensometer is equipped with a 3k Ω thermistor for reading temperature. The thermistor gives a varying resistance output as the temperature changes. So the temperature can also be read using an ohmmeter.

Manual readings of displacement and temperature of the ERI can be taken either directly on the cable end or through a switching panel using the MB-6T or MB-6TL readout unit.

To facilitate reading a cluster of gages, the lead wires from each individual gage can be connected to a switching panel. The wiring instructions for connecting the gages to the wiring block with the junction box are included in the junction/switchbox manual.

4.2 TAKING MEASUREMENTS

The readout unit MB-6T(L) with the four-pin, male, panel-mounted electrical connector is supplied with one multi-core cable fitted with a mating female connector at one end and a set of four color coded alligator clips at the other. The conductor's insulation is color coded to match that of the alligator clips and the instrument cable conductors' insulation jacket.

Connect the alligator clips to the gage lead wire according to the table below.

Cable	Connections			
	Wire High (red)	Wire Low (black)	Temp. High (white)	Temp. Low / Shield (green)
IRC-41A(P)	red	black	white	green shield

Table 1: Wiring code for electrical cables

To obtain a reading, move the MB-6T(L) GAGE selector to position 2 (JM) and the THERMISTOR selector to position B (3K).

Then, flick the power switch towards the "ON" position. The display will successively show:

- the readout self-testing sequence
- the gage and thermistor settings
- the gage NORMAL (N) and LINEAR (L) readings and the temperature of the gage in degrees Celsius and Fahrenheit.

Record these numbers as they appear on the display.

Physically, the NORMAL reading is the vibration period in μs of the wire (previously called N) and the LINEAR reading is the strain of the gage (previously called ε).

Note: If you use a MB-6T(L) readout unit that was built prior to February 1995, contact RocTest – Telemac for appropriate selection position and calibration data.

The jumper cables should never be short-circuited when they are connected to the readout unit front panel.

4.3 QUICK VERIFICATION OF MEASUREMENTS

On site, even before converting raw readings into engineering values, several checks can be done to prevent a bad measurement.

- Compare readings to previous ones. Are they in the same range? Are they changing slowly or abruptly? Consider external factors that can affect the measurements like construction activities, excavations or fills...
- In any case, it is advised to take several readings to confirm the measurement. Then, repeatability can be appreciated and dummy readings erased.

5 CONVERSION OF READINGS

5.1 DISPLACEMENT VALUE

For the absolute measurement of the displacement, the following equation applies using LINEAR units displayed by the MB-6T(L):

$$D = A \cdot L^2 + B \cdot L + C$$

where D = displacement in millimetres

A, B, C = calibration factors (see calibration sheet)

L = reading in LINEAR units (LU)

Example:

With $L = 6\,000$ LU

$A = -1.0839\text{E-}08$ mm/LU²

$B = 4.6608\text{E-}03$ mm/LU

$C = -1.4810\text{E+}01$ mm

We get: $D = 12.76$ mm

Note that increasing readings in LINEAR units indicate increasing displacement.

To get the relative displacement, just subtract the initial reading to the absolute reading.

$$D_r = D - D_0$$

where D_r = relative displacement in millimetres

D = absolute reading in millimetres

D_0 = initial reading in millimetres

If the frequency is measured, convert it into LINEAR units using the following equation:

$$L = K \frac{F^2}{1000}$$

where L = reading in LINEAR units

K = gage constant for ERI fill extensometer = 1.0000

F = frequency in Hz

Example:

With $F = 1\,739$ Hz,

We get: $L = 1.0 \times \frac{1739^2}{1000} = 3\,024.1$ LU

5.2 TEMPERATURE VALUE

Although the MB-6T(L) readout box gives directly the correct value of temperature (in °C and in °F) (with the thermistor selector on position B), temperature can be read with an ohmmeter.

To convert the resistance value into temperature reading, please refer to the instruction manual of the TH-T gage.

5.3 TEMPERATURE CORRECTION

Material used in the vibrating wire sensors are specially chosen to minimize the temperature effects on the measurements. The thermal coefficient of expansion of the sensor body is very close to the wire's one, so that the temperature effects are self-compensated.

However, a slight temperature coefficient still exists. If maximum accuracy is desired or if huge temperature variations are suspected, it can be calculated on demand during the calibration of the instrument in factory.

Since the ERI fill extensometers are generally placed into embankment dams, temperature is quite constant and displacements are great. Temperature correction

seems in that case useless.

If anyway, in a special installation, a correction should be applied, use the following relation:

$$D_T = C_T(T - T_0)$$

where D_T = displacement due to temperature variations, in millimetres

C_T = calibration factor for temperature (see calibration sheet), in mm/°C

T = current temperature reading, in degrees Celsius

T_0 = initial temperature reading, in degrees Celsius

Then the corrected displacement is get with the relation:

$$D_c = D - D_T$$

where D_c = corrected displacement, in millimetres

D = previous displacement without correction, in millimetres

D_T = displacement due to temperature effects, in millimetres

Be careful to work all the time with the same units to apply correctly the temperature correction.

6 TROUBLESHOOTING

Maintenance and troubleshooting of vibrating wire transducers are required. Periodically check cable connections and terminals. The transducers themselves are sealed and cannot be opened for inspection.

6.1 UNSTABLE READING

- Check if the same troubles occur with other instruments. If so, compare cable routes or check the readout unit.
- Is the shield drain wire correctly connected to the readout unit?
- Isolate the readout unit from the ground by placing it on a piece of wood or similar non-conductive material.
- Check the battery of the readout unit.
- Check for nearby sources of electrical noise such as motors, generators, electrical cables or antennas. If noise sources are nearby, shield the cable or move it.
- If a data logger is used to take the readings, are the swept frequency excitation settings

well adjusted?

- The sensor may have gone outside its range. See previous records.
- The sensor body may be shorted to the shield. Check the resistance between the shield drain and the sensor housing.
- Check the integrity of the cable.
- The sensor may have been damaged by shocks.

6.2 NO READING

- Check the battery of the readout unit.
- Check if the same troubles occur with other instruments. If so, the readout unit may be suspected and the factory should be consulted.
- If a data logger is used to take the readings, are the swept frequency excitation settings well adjusted?
- The sensor may have gone outside its range. See previous records.
- Check the coil resistance. Nominal coil resistance is $190\Omega \pm 10\Omega$, plus cable resistance (22 gage copper = approximately $0.07\Omega/m$).
 - If the resistance is high or infinite, a cut cable must be suspected.
 - If the resistance is low or near zero, a short must be suspected.
 - If resistances are within the nominal range and no reading is obtained, the transducer is suspect and the factory should be consulted.
- Cuts or shorts are located, the cable may be spliced in accordance with recommended procedures.
- The sensor may have been damaged by shocks or water may have penetrated inside its body. There is no remedial action.

6.3 TEMPERATURE TROUBLES

If troubles occur when reading the temperature, this is likely due to a cable cut or short because of the technology used (simple thermistor). Check the cable and splice it in accordance with recommended procedures.

If furthermore, no reading of displacement is got, water may have penetrated inside the sensor body. There is no remedial action.

7 MISCELLANEOUS

7.1 ENVIRONMENTAL FACTORS

Since the purpose of the extensometer installation is to monitor site conditions, factors which may affect these conditions should always be observed and recorded. Seemingly minor effects may have a real influence on the behaviour of the structure being monitored and may give an early indication of potential problems. Some of these factors include, but are not limited to: blasting, rainfall, tidal levels, excavation and fill levels and sequences, traffic, temperature and barometric changes, changes in personnel, nearby construction activities, seasonal changes, etc.

7.2 CONVERSION FACTORS

	To Convert From	To	Multiply By
LENGTH	Microns	Inches	3.94E-05
	Millimetres	Inches	0.0394
	Meters	Feet	3.2808
AREA	Square millimetres	Square inches	0.0016
	Square meters	Square feet	10.7643
VOLUME	Cubic centimetres	Cubic inches	0.06101
	Cubic meters	Cubic feet	35.3357
	Litres	U.S. gallon	0.26420
	Litres	Can-Br gallon	0.21997
MASS	Kilograms	Pounds	2.20459
	Kilograms	Short tons	0.00110
	Kilograms	Long tons	0.00098
FORCE	Newtons	Pounds-force	0.22482
	Newtons	Kilograms-force	0.10197
	Newtons	Kips	0.00023
PRESSURE AND STRESS	Kilopascals	Psi	0.14503
	Bars	Psi	14.4928
	Inches head of water*	Psi	0.03606
	Inches head of Hg	Psi	0.49116
	Pascal	Newton / square meter	1
	Kilopascals	Atmospheres	0.00987
	Kilopascals	Bars	0.01
Kilopascals	Meters head of water*	0.10197	
TEMPERATURE	Temp. in °F = (1.8 x Temp. in °C) + 32 Temp. in °C = (Temp. in °F - 32) / 1.8		

* at 4 °C

E6TabConv-990505

Table 2: Conversion factors

APPENDIX 1

EXAMPLE OF CALIBRATION SHEET



CALIBRATION DATA SHEET
VIBRATING WIRE EMBANKMENT EXTENSOMETER

Model: ERI-25
Serial number: 117A04049
Range: 25 mm
Thermistor type: 3 kohms
Cable model: IRC-41A
Cable length: 235 ft

Color code: red & black (coil) green & white (themistor)

Displacement mm	Reading LU	F. S. Error %
6,25	4564,8	0,04
12,50	5948,5	-0,12
18,75	7318,5	0,12
25,00	8720,4	-0,04
Max. error (%):		0,12

A: -1,0839E-08 mm/LU²
B: 4,6608E-03 mm/LU
C: -1,4810E+01 mm

Displacement is calculated with the following equation:

$$D = AL^2 + BL + C$$

D : Displacement in mm
A,B,C: Calibration factors
L : Current reading in linear units (LU)

** Linear units obtained with MB-6T in position 2, K=1.000*

Traceability no: TR-03-06
Certificate No: 117A04049

Calibrated by: Sony Caron

Date: 04/06/15